

IV-11 VFD tube clock

User manual v1.2.2

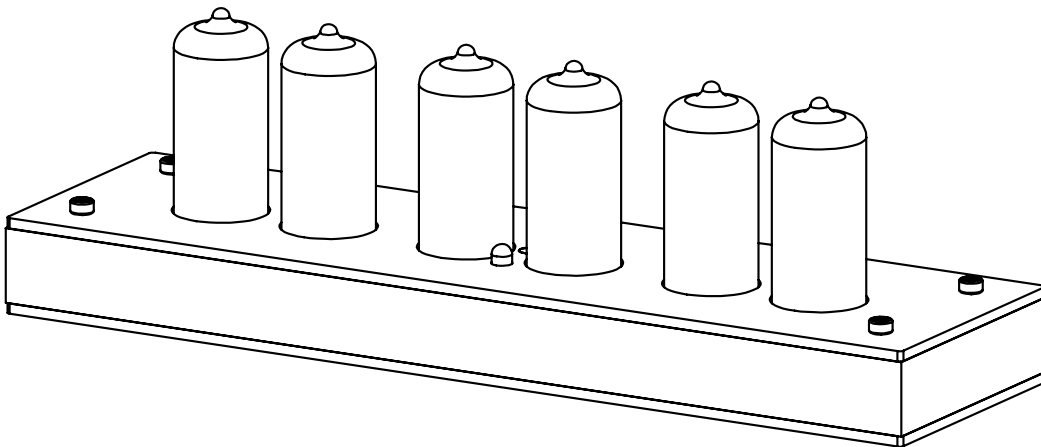

Designer: Yan Zeyuan. China
Website: <http://www.nixieclock.org>
E-mail: yanzeyuan@qq.com

Attention

- ◇ Attention: To prevent accidental damage, do not place this clock on an uneven surface.
- ◇ Warning: The clock has an internal high voltage circuit, DO NOT open; DO NOT touch the components while the clock is operating.
- ◇ Warning: In order to ensure normal operation, please use only the included power adapter and USB cable.
- ◇ Warning: Clock is for indoor use only.
- ◇ Warning: Please do not let children touch the clock.

Catalogue

Introduction	
Package Contents.....	5
Appearance.....	6
IR Remote.....	7
Power Adapter.....	7
Features.....	8
Technical Specifications.....	8
Get Ready Before Use	9
Power On/Off.....	9
Operational Beep Tones.....	9
Connect GPS Receiver.....	10
Cleaning.....	10
Basic Operation	11
Power On/Off.....	11
Set Brightness.....	11
Display Time.....	12
Set Time.....	13
Display Date and Weekday.....	14
Set Date.....	15
Display Alarms.....	16
Set Alarms.....	17
Set Auto On/Off Time.....	18
Display Temperature.....	19
Enter Menu.....	20
Menu Setup	20
Menu 1 Set Time Format.....	21
Menu 2 Set Date Format	21

Menu 3 Set UTC Time Zone.....	21
Menu 4 Display Status of GPS.....	22
Menu 5 Set Baud Rate of GPS.....	22
Menu 6 Set Interval of Date Display.....	22
Menu 7 Set Leading Zero.....	23
Menu 8 Set Digital Switching Effects.....	23
Menu 9 Set Digital Switching Speed.....	24
Menu 10 Set Backlight Color.....	24
Menu 11 Set Effects of Backlight.....	25
Menu 12 Set Beep Tones.....	25
Menu 13 Display Firmware Version.....	25

Reference

Special Remarks.....	26
----------------------	----

Package Contents

Before getting started, please check the contents of the package. If any parts are missing, please contact the seller. Package consists of the following items:

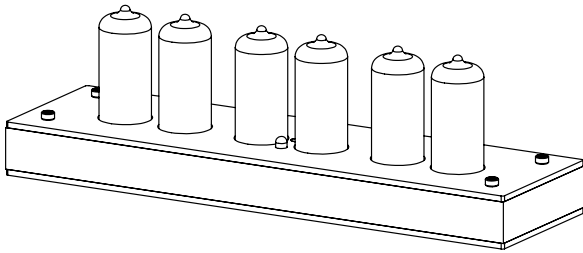

VFD tube clock

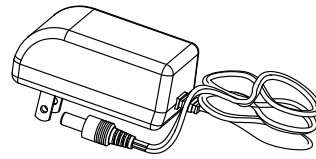

Power Adapter

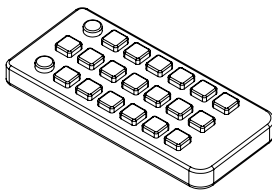

IR Remote Controller

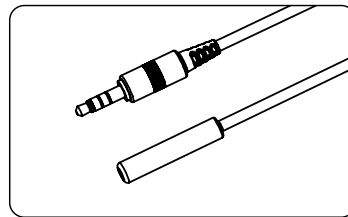

Temp. Sensor



- The included power adapter will allow normal operation. DO NOT use other type of power adapter.

Appearance

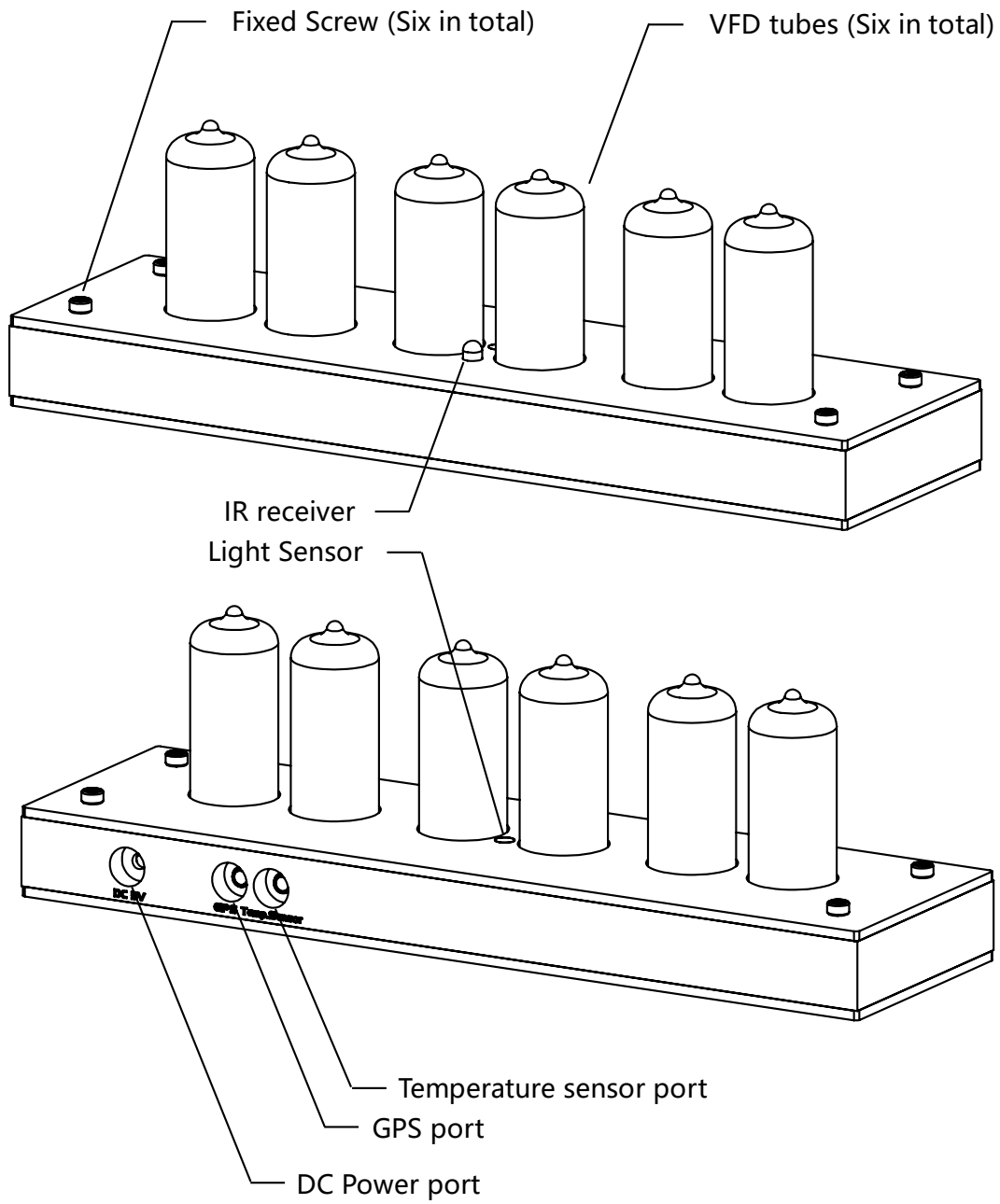

IR Remote



Power	Power ON/OFF
LIGHT	Set brightness
SET	Enter setup
DATE	Check date
ALARM	Display alarm
TEMP	Display temperature
LEFT/RIGHT	Set position
FUNC	Enter menu
OK/CANCEL	Save & exit
NUMBER	Enter numbers



- IR controller uses (1) CR2025 cell. Transportation rules may not permit shipment with lithium battery installed. Please insert battery or remove the protective insulator to operate.

Power Adapter

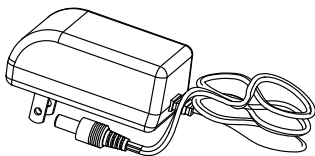

- For Global use 50/60Hz.
- Voltage Range:
Input: 100-240VAC, ~0.4A.
- Standard USB output.
- Output DC 5V, Max 1500mA.



- In order to insure proper operation, use only the supplied power adapter and high current USB cable.

Features

- (Six) IV-11 VFD display tubes.
- Display hour, minutes and second (12 or 24 format operational)
- Display year, month and day and Chinese lunar date.
- Display day of week.
- Two alarm clock.
- GPS adjust, automatic adjust Date and Time. (GPS receiver is optional)
- GMT time zone functions, the clock will calculate the local time based on satellite.
- Temperature display (°C or °F). (Temperature sensor is optional)
- Alternate between Time and Date display. (Interval of Date display can be set)
- Switch On/Off automatically.
- Automatically adjusts brightness level of VFD tubes and LEDs based on ambient lighting.
- Ten transition effects for the digits.
- Ten transition speeds for the digits.
- Background lighting effects includes eight colors, Fade in-out, On and Off.
- IR remote controller operation.
- Built-in high precision RTC module, accurate to within 60s per year.
- Built-in backup lithium battery will maintain clock time more than 3 years.

Technical Specifications

Name	Specifications
VFD tubes	IV-11 (IB-18 1980-1992 made in USSR)
Voltage of DC input	DC 5V (3.5mm/1.35mm)
Operation current	Max 900mA
GPS requirement	TTL port, 2400-9600bps, 3.5mm headset plug
Dimension	Base 240mm(L) x 70mm(W) x 25mm(H) Height of VFD tube 50mm, diameter 22mm
Material of housing	Hard wood and acrylic plates.
Operating temperature	0°C to 60°C (32°F to 140°F)
Weight	360g

Get Ready Before Use

Power On/Off

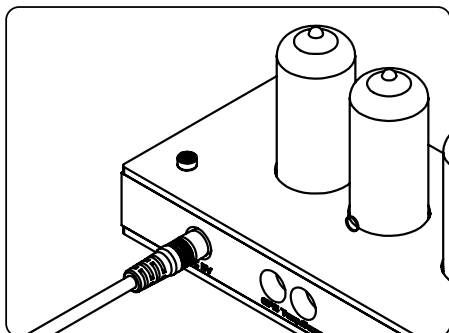

- Turn on the power by connecting the power adapter plug into the clock.
- Clock will power on when plugged in.



- During long periods of non-use, please disconnect the power.

Operation Beep Tones

- The clock will emit a beep during operation by IR remote controller.
Description of beep tones:

Beep	Description	Meaning
Be	a short beep	Power on/Normal Operation
Be...	a long beep	Power off/Save setting/GPS sync
Bebebebe	four short beeps	Cancel/Set error/Alarm



- Beep tones can be switched off, please consult MENU 12.

Connect GPS Receiver (GPS receiver is optional and may be purchased)

GPS receiver can synchronize the date and time with satellites for high precision time.

- Before connecting GPS receiver, please make sure it has 3.5mm headset plug.
- Please plug-in the GPS receiver at the back of the clock.
- Please place the GPS receiver outdoor or near a window.
- When the satellites are online, clock will update the date and time from satellites.
- You can check the connection status at MENU 4.



- We recommend using only the optional GPS receivers.
- GPS requires TTL interface and follows NMEA0183 protocol.
- The clock supports baud rate of 2400bps, 4800bps or 9600bps.

Cleaning

Consider the notes below before cleaning the clock.

- Please power off and disconnect the power cable before cleaning.
- Do not use any cleaning agent or wet wiper.
- We suggest use soft cloth or brush to avoid scratching the housing finish.

Basic Operation

Power On/Off

Toggle the clock on/off by pressing **POWER** button on IR remote controller.

- Press **POWER** button of IR remote to power off.
- Press **POWER** button again to power on.

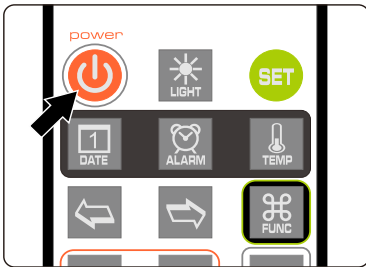

- With clock display off, the power to the tubes is completely removed for long tube life.
- During long periods of non-use, please disconnect the power.

Set Brightness

Brightness of tubes and backlight can be set to eight levels, brightness also can be set automatically by ambient light.

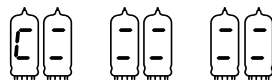
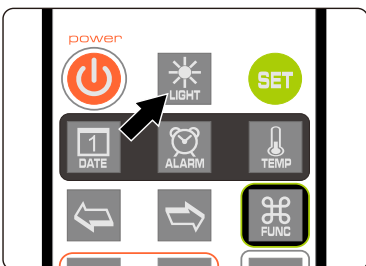

Level 1 (the darkest)

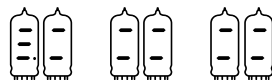

Level 2

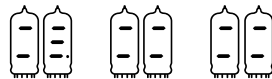

Level 3

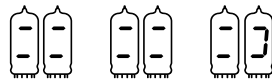

Level 8 (the brightest)

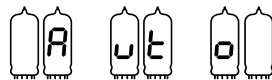

Automatic



- When brightness is set to automatic, the ambient light controls the brightness of the VFD tubes and LED backlight so that the clock will not disturb your sleep at night.

Display Time

- The clock will display real time after power on.

E.g.: now time is PM 8:15:30, will display:

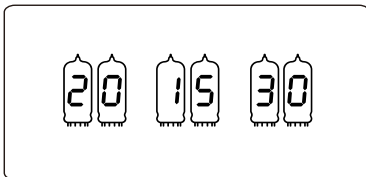

- Digits on the left are HOURS, digits in the middle are MINUTES; digits on right are SECONDS.

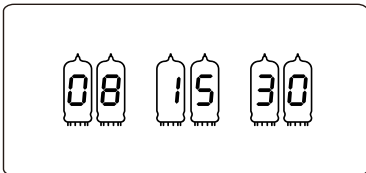

- Time will display as shown left when time format set to 12H.

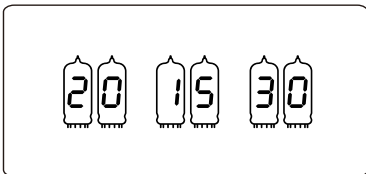

- Time will display as shown left when time format set to 24H.

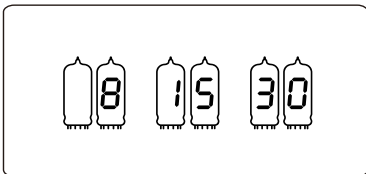

- Time will display as shown left when lead zero set off.

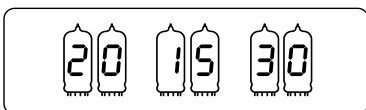

- Date will display for three seconds with set interval.

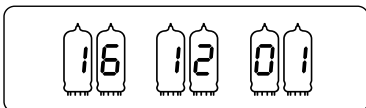

- To set the interval, please consult MENU 6.



- To set 12/24 time format, please consult MENU 2.
- To set leading zero, please consult MENU 7.
- To control digital switching effect setting, please consult MENU 8.
- To control digital switching speed setting, please consult MENU 9.

Set Time

Time can be set manually or synchronized by satellite using the optional GPS receiver. To set time manually:

- Press **SET** button enter time setting mode, 2 digits on the right start blinking.

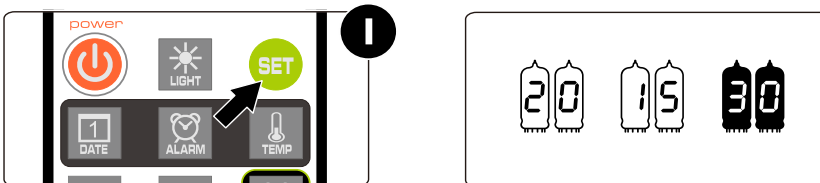

- Press **LEFT/RIGHT** button select position of setting.

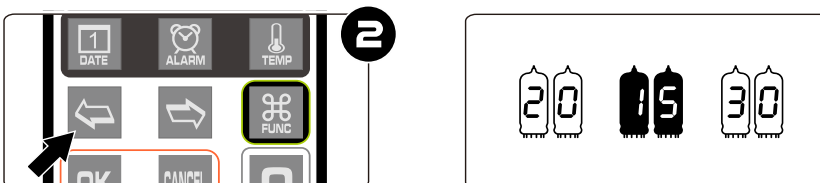

- Press **0-9** button input HOUR, MINUTE or SECOND.

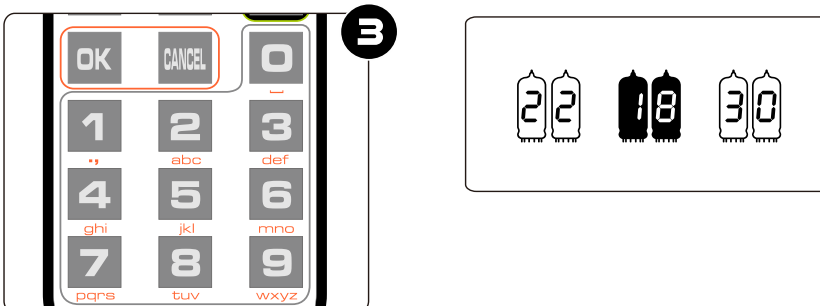

- Press **OK** button to save setting, press **CANCEL** button to abort.

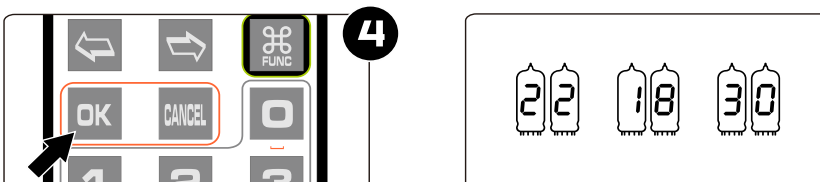

- Time will display in 24 hour mode HH:MM:SS during setting mode.
- Any digits can be input during setting, but system will check if the time entry is valid when you save it. Invalid times will not be saved.

Display Date and Weekday

The clock can display year, month and day and Chinese lunar date and weekday.

- Press **DATE** button once to display date; press twice to display Chinese lunar date, press three times to display weekday.

E.g.: Now date is Dec 1, 2016, Chinese lunar date is 2016-11-03.



- Press **DATE** button once, display date.

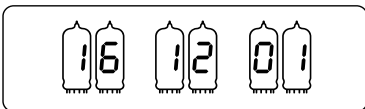

- Display date 2016-12-01, shown left.

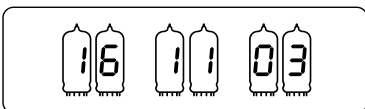

- Press **DATE** button twice, display Chinese lunar date 2016-11-03, shown left.

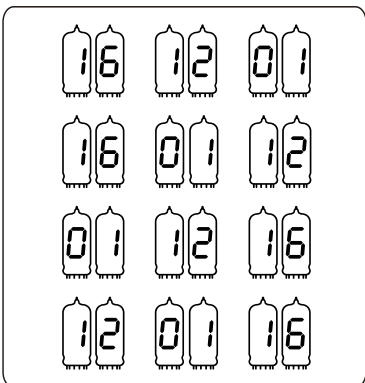

- Date format set to YY-MM-DD, shown left.
- Date format set to YY-DD-MM, shown left.
- Date format set to DD-MM-YY, shown left.
- Date format set to MM-DD-YY, shown left.

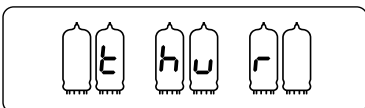

- Press **DATE** button three times, display shows weekday as left image.



- After 3 seconds of display date, the clock will return to time display mode.
- Date format can show YY-MM-DD, YY-DD-MM, DD-MM-YY or M-DD-YY, please consult MENU 1 to set the date format.

Set Date

Date can be set manually or synchronized by satellite with the optional GPS receiver. To set date manually:

- Press **DATE** button to show the date.

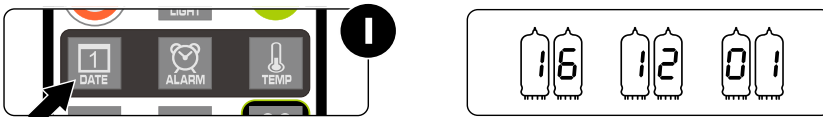

- Press **SET** button to enter set date mode, 2 digits on the right start blinking.

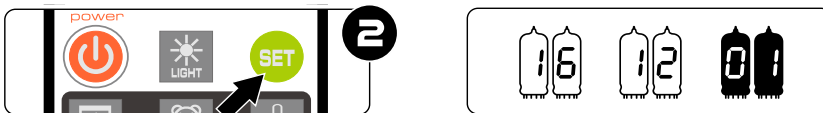

- Press **LEFT/RIGHT** button to select setting position.

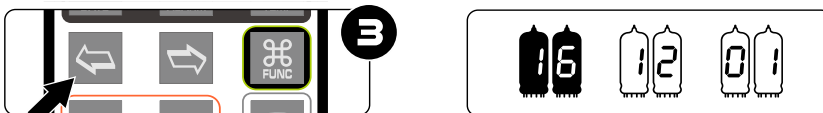

- Press **0-9** button to enter YEAR, MONTH or DAY.

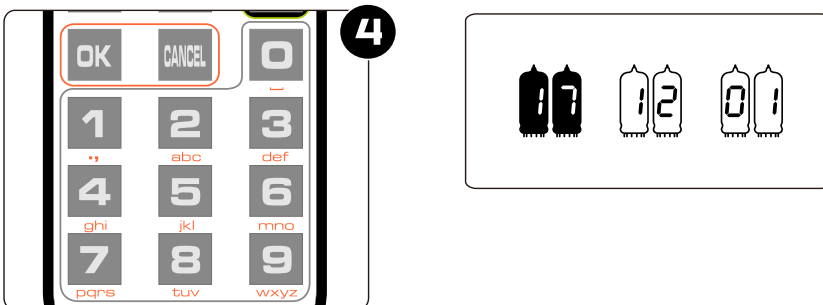

- Press **OK** button to save setting, press **CANCEL** to abort.

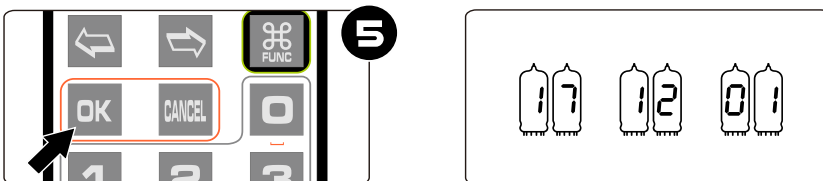

- In setting mode, the date format always displayed as YY-MM-DD.
- Any digits can be input during setting, but system will check if the date entry is valid when you save it. Invalid dates will not be saved.
- Chinese lunar date and day of week does not need to be set. The system will calculate it automatically.

Display Alarms

The clock can support 2 alarms, each can be active separately.

- Press **ALARM** button to check alarm 1, press twice to check alarm 2.

E.g.: Alarm 1 set to 7:00 AM.

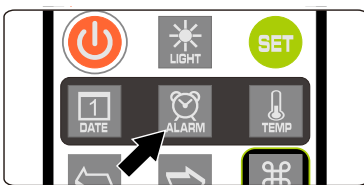

- Press **ALARM** button to display alarm 1 as shown left.

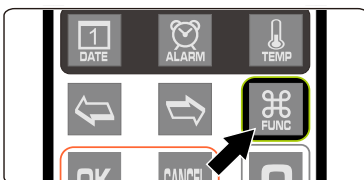
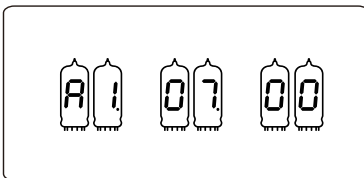

- Press **FUNC** button during display alarm to activate or disable alarm.

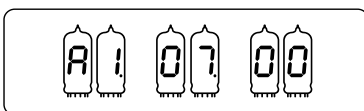

- Alarm display as shown left when active.

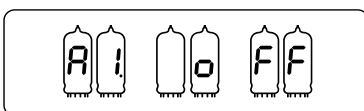

- Alarm display as shown left when disabled.



- The clock will return to time display mode from display alarm after 3 seconds.
- Alarm will sound for 60s.
- To stop alarm sound by press any button of IR controller.

Set Alarms

- Press **ALARM** button to select alarm, digits on the left will show alarm number, A1 means alarm 1, A2 is alarm 2.

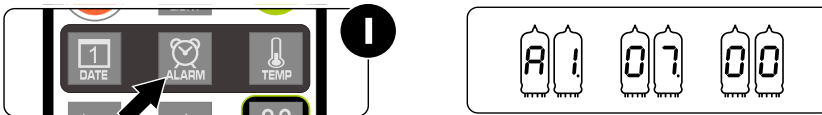

- Press **SET** button to enter alarm set mode, HOUR blinks during setting. If alarm disabled and show OFF please press **FUNC** button to active it before setting.

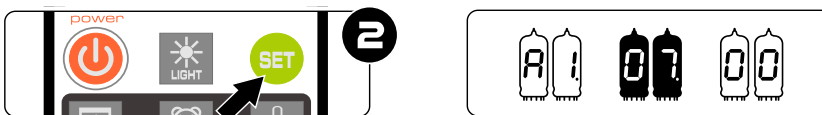

- Press **LEFT/RIGHT** button to select set position.

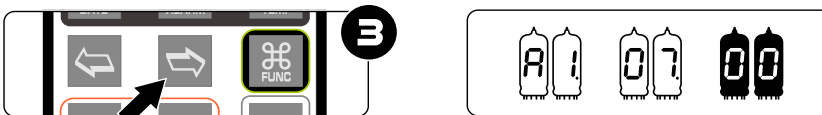

- Press **0-9** button to input HOUR or MINUTE.

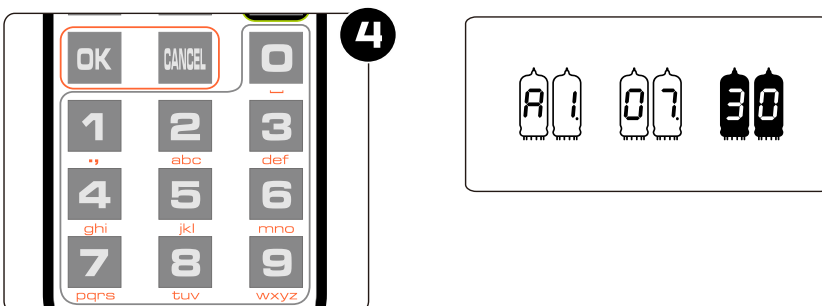

- Press **OK** button to save setting, press **CANCEL** to abort.

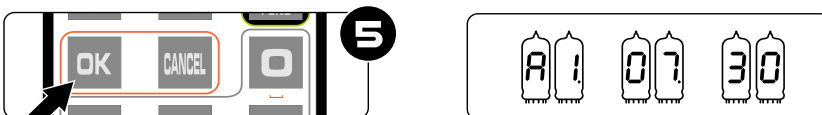

- Any digits can be input during setting, but system will check if the alarm time entry is valid when you save it. Invalid alarm times will not be saved.
- Consult DISPLAY ALARMS for information on how to enable/disable alarm.

Set Auto On/Off time

- Press **ALARM** button 3 times to display AUTO ON time, press 4 times to display AUTO OFF time. Press **FUNC** button to activate before setting if auto on/off is disabled.

Eg: AUTO ON time set to 8:00 AM, AUTO OFF time set to 10:00 PM.

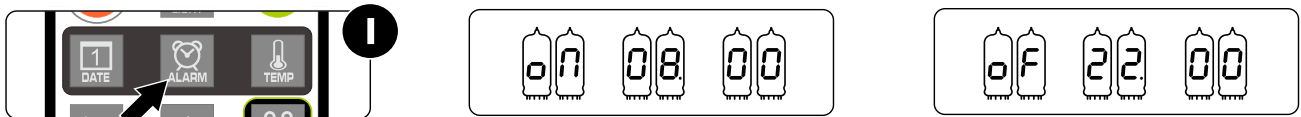

- Press **SET** button to enter auto on/off time setting mode, HOUR blinks.



- Press **LEFT/RIGHT** button to select setting position.

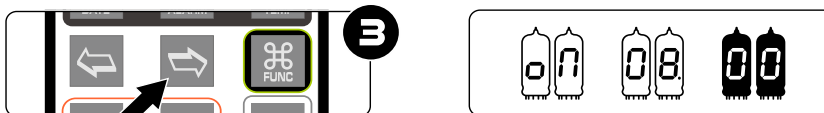

- Press **0-9** to input HOUR or MINUTE.

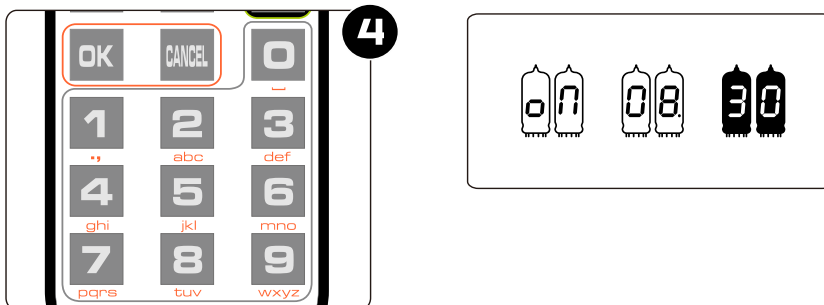

- Press **OK** button to save setting, press **CANCEL** to abort.

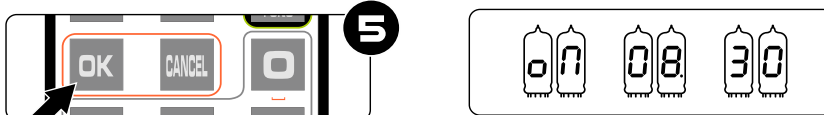

- Press **FUNC** to activate or disable auto on/off when displaying auto on/off time.

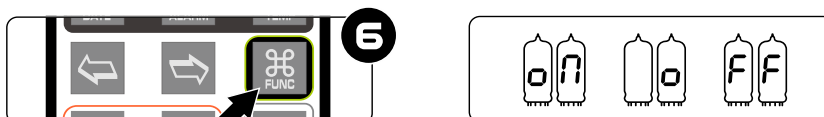

- Any digits can be input during setting, but system will check if the time entry is valid when you save it. Invalid times will not be saved.
- System default will check auto on/off mode and time every minute.

Display Temperature (the temperature sensor is optional and may be purchased)

The clock can display temperature using the temperature sensor.

- Press **TEMP** button to display current temperature.

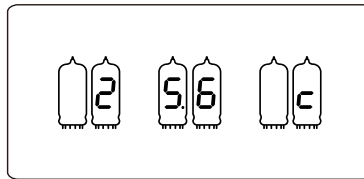
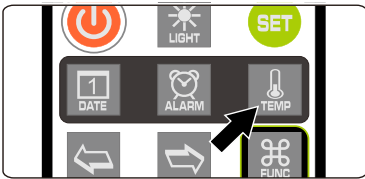

- Press **FUNC** button to switch unit °C/°F.

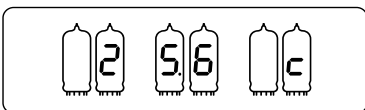

- Temperature unit °C shown left.

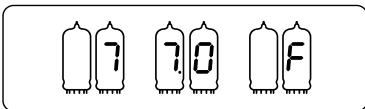

- Temperature unit °F shown left.



- The clock will return to time display mode after 3 seconds.
- Temperature is recalculated after units are changed between °C/°F.

Enter Menu

There are 13 different items in the menu for setting system parameters.



- Press FUNC button to enter menu.

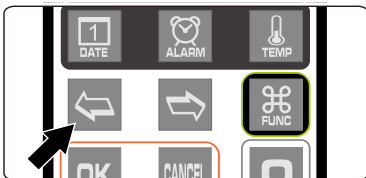

- Press LEFT/RIGHT to select menu items.
- Press SET button to set current menu item.



- The clock will return to time display mode after 3 minutes if there are no menu operations.

Menu Setup

Setting menu items follow steps below.



- Press OK button enter setup.



- Press LEFT/RIGHT button to change parameters.

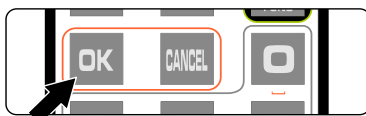

- Press OK button to save setting.
- Press CANCEL button to abort.

Menu 1 Set time format

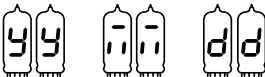
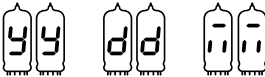
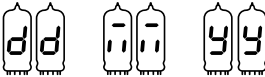
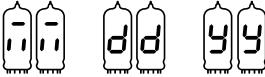
Display	Parameter	Remarks
	YY-MM-DD	Default
	YY-DD-MM	
	DD-MM-YY	
	MM-DD-YY	

Menu 2 Set date format

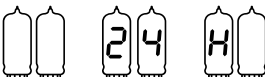
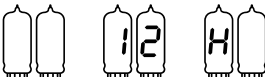
Display	Parameter	Remarks
	24H	Default
	12H	

Menu 3 Set UTC time zone

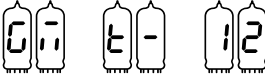
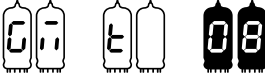
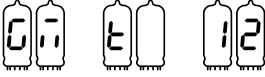
Display	Parameter	Remarks
	GMT -12	
	GMT-12 to GMT+12 ☒	Default GMT+8
	GMT +12	

Menu 4 Display status of GPS

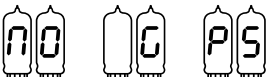
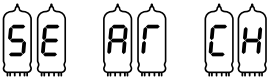
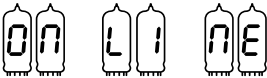
Display	Parameter	Remarks
	No GPS connection	
	Searching GPS signal	
	GPS online	



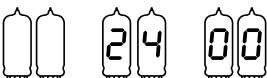
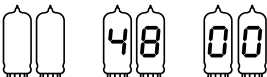
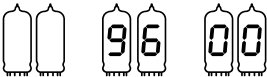



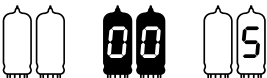
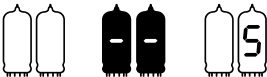
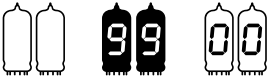





Menu 5 Set baud rate of GPS

Display	Parameter	Remarks
	2400bps	
	4800bps	
	9600bps	Default































Menu 6 Set interval of date display

Display	Parameter	Remarks
	0s	Default no interval display
	Interval time can be set to 1-99s	
	99s	



Menu 7 Set leading zero

Display	Parameter	Remarks
  	Display e.g.:   	Default
  	Off display e.g.:   	

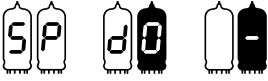

Menu 8 Set digital switching effect

Display	Parameter	Remarks
  	Cross-fading	Default
  	Fade in-out	
  	Slot machine	
  	Scanning	
  	Jumping (up-down)	
  	Wiping (up-down)	
  	Jumping (left-right)	
  	Wiping (left-right)	
  	Blinking	
  	Normal	





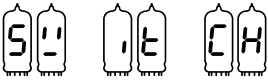
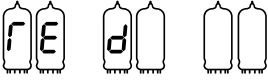
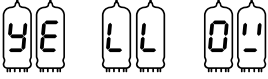
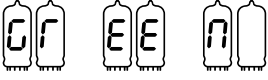

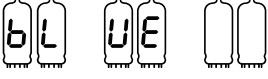
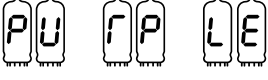
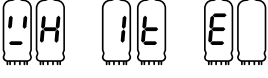





Menu 9 Set digital switching speed

Display	Parameter	Remarks
	Slowest	
	Speed can be set from 0 to 9	Default 5
	Fastest	







Menu 10 Set backlight color

Display	Parameter	Remarks
	Switch automatically	Default
	Red	
	Yellow	
	Green	
	Cyan	
	Blue	
	Purple	
	White	



Menu11 LE DE Set effects of backlight

Display	Parameter	Remarks
  	Fade in-out every 1s	
  	Setting from 1s to 5s	Default 2s
  	Always off	
  	Always on	

Menu12 bE EP Set beep tones

Display	Parameter	Remarks
  	Beep tones on	Default
  	Beep tones off	

Menu13 V1 20 Display firmware version

Display	Parameter	Remarks
  	Version 1.2.0	

Special Remarks

- These VFD tubes were produced between 1980-1992, and there may be some differences between tubes and manufacturing lots. This is normal, and will not affect the tube operation.
- The clock will become warm and heat up during operation due to the internal DC-DC converter. This is normal operation and no cause for concern.
- In order to insure proper operation, use only the supplied power adapter.